

Power 4

The universal booster for almost all digital systems



Table of Contents

1. General Information	4
1.1 Description	4
2. Installation	5
2.1 The Connectors	5
2.2 Connection Transformer and Track	5
2.3 Connecting to the Center via LocoNet	8
2.4 Connecting to the Center via the Märklin booster connector	10
2.5 Connecting further Boosters	10
2.6 Connecting of a Center via the DCC Booster input	11
2.7 Selecting Operating Mode	11
3. Booster	12
3.1 Description	12
3.2 Choosing the Control Signal Socket	12
3.3 Output Power	13
4. LocoNet Operation	14
4.1 Configuring the Power 4 via LocoNet	14
4.1.1 Calling a Power 4	14
4.1.2 Reading and Programming a LocoNet Module	15
4.1.3 The Universal Address 65535	16
4.1.4 List of LocoNet CVs	17
4.2 Power 4 Configuration	17
4.2.1 Basic setting via LocoNet	18
4.2.2 Switching off behavior	19
4.2.3 Switching Track Polarity	19

4.3 Power 4 single switch-off and monitoring	20
4.4 Load and operating temperature of the Power 4	20
5. Reversing Loop Automation	21
5.1 Description	21
5.2 Connection	21
6. Brake Generator	24
6.1 Description	24
6.2 Choice of socket for the control signal	24
6.3 Choice of operating mode	24
6.4 Connection	25
6.5 Brake Generator without connecting to the center	26
7. RailCom	27
8. Error Indication	27

1. General Information

1.1 Description

The Power 4 is a short circuit proof multiprotocol booster with a power output of 3.5 A. It has integrated reversing loop automation to which several reversing loop relays can be connected using the screw terminals. It can be switched to operate as an NMRA compatible DCC brake generator.

All outputs have short circuit protection.

The booster is compatibly with centers from Uhlenbrock, Arnold, Lenz and Märklin.

Maximum permissible input voltage

18V AC

Maximum Load on the Track

Power 4 – 3.5A

Dimensions

104 x 58 x 33 mm

Recommended Transformer

52 – 70 VA (e.g. Uhlenbrock Transformer 20 070)

2. Installation

2.1 The Connectors

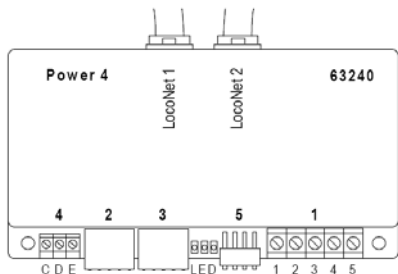

- | | | |
|---|-----------------------|------------------------------------|
| 1 | 5 pin screwing strip: | Transformer, Track, Reversing loop |
| 2 | 5 pin connector: | Märklin Booster Socket |
| 3 | 5 pin connector: | Märklin Booster Socket |
| 4 | 3 pin screwing strip: | Connection of DCC center |
| 5 | 4 way DIP switch | For setting operating mode |

2.2 Connection Transformer and Track

Transformer and track are connected to the 5-pin screw terminal strip 1 as follows:

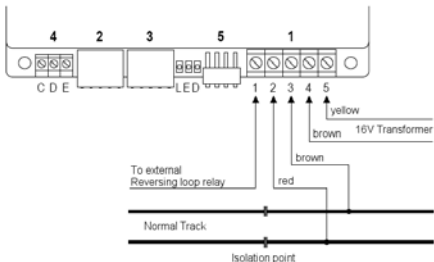

- 1 Output to external reversing loop relay
- 2 Digital Power for the track (Märklin red)
- 3 Digital Power earth for the track (Märklin brown)
- 4 Earth for 16V AC from transformer (Märklin brown)
- 5 16 AC from transformer (Märklin yellow)

Transformer

For trouble free operation the Power 4 requires a transformer of minimum of 52VA and 16V AC. For full capability we recommend utilization of a transformer with 70 VA, e.g. Uhlenbrock into 20070. The transformer output should not exceed 18V~. The transformer output is connected to terminals 4 (brown) and 5 (yellow) of the 5-pin screw terminal 1.

2 Rail Track

2-rail track is connected to the terminals 2 and 3 of the 5-pin screw terminal 1.



3 Rail Track

With 3-rail track (Märklin) the brown cable is connected to terminal 3 and the red cable (neutral conductor) to terminal 2.

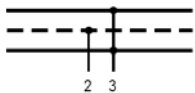

Safety Note: If the Power 4 is used with an Intellibox or a Märklin center the ground wires from all transformers that feed boosters and the center must be connected together.

If this is not done the booster output of the Intellibox can be destroyed if the track sections which are fed by Intellibox and boosters are mutually cross wired and the separating isolation is bridged.

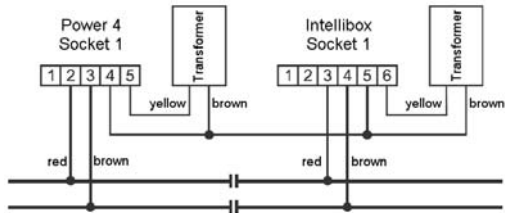

2.3 Connecting to the Center via LocoNet

The booster can be connected with the LocoNet B socket of the Intellibox, Intellibox IR, Intellibox basic or the Intellibox II with the enclosed LocoNet cable.

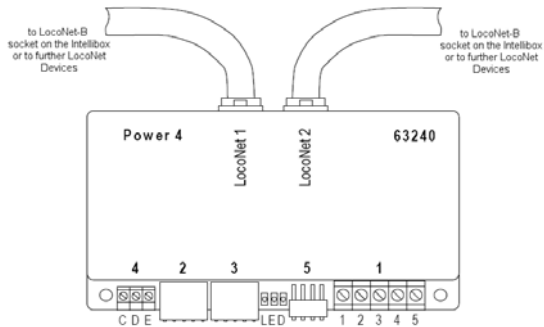

LocoNet centers that control a LocoNet with RailSync signals (rail control signal), like the DAISY system, Fleischmann TwinCenter, Fleischmann LokBoss, Fleischmann ProfiBoss and all Digitrax centers can likewise be connected here. The two LocoNet sockets on the Power 4 are identical and can alternatively be used for connecting to the center or for further LocoNet devices.

For connecting to the center a straight-through LocoNet cable should be used. For this Uhlenbrock LocoNet cables 62015, 62025, 62045 and 62065 are available. The device is equipped with straight-through cable 62045.

Note: If a crossed LocoNet cable (62010, 62020, 62040 or 62060) is used the polarity is exchanged in the booster's electric circuit. If when crossing the track isolation between two track sections a short circuit occurs, Bit 5 of LNCV 3 can be used to swap the track polarity (see chapter 4.2.3).

Info on the LocoNet Cables

In the crossed version pin 1 is connected with pin 6, pin 2 with pin 5 etc.

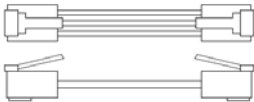

In the straight-through version the pins are wired 1:1, thus to pin 1 connected with pin 1, pin 2 with pin 2 etc.

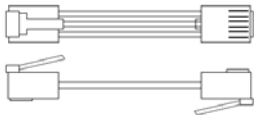

2.4 Connecting to the Center via the Märklin booster connector

The Intellibox or Märklin central processing unit can be connected to this socket as centers. The electrical connection is made by a flat strip cable 65610.

Socket 2 on the booster is connected with the socket 5 on the Intellibox or to the booster output of the Märklin center.

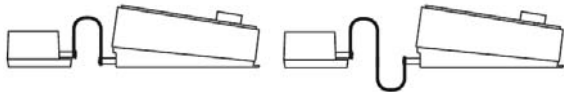

Power 4 and Intellibox or M 6021

Power 4 and M 6020

The plugs are oriented so that the cables to Uhlenbrock devices and the Märklin center 6021 go upward and those on the Märklin Central Processing Unit 6020 run downward.

2.5 Connecting further Boosters

Further Power 4 or the Märklin boosters 6015 and 6017 can be connected to socket 3 of the device.



Power 4 and Power 4

Power 4 and M 6017

Power 4 and M6015

The plugs must be oriented so that the cables into the Uhlenbrock devices and the Märklin booster 6017 run upward and with the Märklin booster 6015 run downward.

2.6 Connecting of a Center via the DCC Booster input

DCC centers are connected to socket 4 of the device. It is possible to connect the booster with an Intellibox, a Lenz Center LZ100, an Arnold Center 86200 or with other centers, which have a DCC Booster input.



- 1 = C = Signal +
- 2 = C = Signal +
- 3 = E = Short circuit reporting wire

2.7 Selecting Operating Mode

DIP switch 5 is used to select the different operating modes of the device.



- On
- Off
- 1 Selection of Input socket
- 2 Selection of Input socket
- 3 Brake generator Mode
- 4 RailCom

DIP Switch	1	2	3	4
LocoNet	Off	Off		
Input Motorola	Off	On		
Input DCC	On	Off		
Operate as Booster			Off	
Operate as Brake generator			On	
RailCom				On

Note: If the booster is changed to a new operating mode it does not take effect until the next time the booster's power is switched on.

3. Booster

3.1 Description

The Power 4 has an output of 3.5 A. All outputs are short circuit proof.

The booster can be used together with different digital centers. In conjunction with the Intellibox it transfers Motorola, DCC and Selectrix protocols to the rails.

Together with the centers from Märklin, Lenz or Arnold it transfers protocols which are supported by those centers.

Note: *Operation with Selectrix centers is not possible for technical reasons.*

3.2 Choosing the Control Signal Socket

The Power 4 can get its control signals from Motorola or DCC centers. Depending on the format these centers are connected with the booster via different connectors. The DIP switch must be adjusted according to the selection.



Switch 1 Off, switch 2 Off – if the device is connected to an Intellibox or another LocoNet center by the LocoNet socket.

Switch 1 Off, switch 2 On – if the device is connected to an Intellibox or a Märklin Central Processing Unit by Socket 2.

Switch 1 On, switch 2 Off – if the device is connected to a DCC Center (Lenz LZ100, Arnold 86200) by the Socket 4.

3.3 Output Power

The Power 4 output voltage depends on the transformer used and the load on the electric circuit. When using a normal model railway transformer with 16V output voltage the maximum no-load potential at the track is 20V.

Note: *The Power 4 is locked to the output voltage of 16V. In order to reduce the booster's output voltage an appropriate transformer with smaller output voltage must be used.*

4. LocoNet Operation

If one operates the Power 4 with a LocoNet center it has many extended functions, like disconnection of individual boosters and monitoring. All of the booster's settings the can be made with LocoNet programming.

4.1 Configuring the Power 4 via LocoNet

LocoNet devices like the Power 4 are set up by LocoNet configuration variables (LNCVs). These LNCVs can be programmed with the help of the Intellibox (starting with software version 1.3), the IB-control (starting with version 1.55) or the TwinCenter (starting with version 1.1).

4.1.1 Calling a Power 4

- Connect the Power 4 to the LocoNet
- On the Intellibox (from Software Version 1.3) press the [menu]-key, immediately followed by the [mode]-key, in order to enter the Basic Settings menu.
- Scroll to "LocoNet Prog." with the [↓]-key
- Press the [→]-key:

```
LocoNet Prog.:  
Art.-Nr.: .....
```

- Enter the part number for the Power 4 (in this case 63240) and press the [↵]-key

```
LN Prog.: 63240  
Modul Adr.: .....
```

- Enter the address of the Power 4 (factory setting is 1) and press the [↵]-key

```
LNPr 63240-00001  
LNCV: ....0=....1
```

The Power 4 part number and the current module address are shown on the upper line. On the lower line the ID number of the LocoNet CV (here 0 for the module address) and its present valid value is located (here 1).

Important: For programming every module requires a module address so that the digital center knows which module is being referred to. The factory setting for Power 4 is 1. If other Power 4 devices are connected to the center these modules must have different addresses. The allowable address range is 1 to 65534. To confirm that the Power 4 is addressed correctly the green LED flashes while the module is in programming mode.

4.1.2 Reading and Programming a LocoNet Module

As with DCC Locomotive decoders the behavior of the Power 4 is adjusted with different Configuration variable (CV). Contrary to Locomotive decoders these CVs are not programmed via the rail but via the LocoNet and are therefore called LocoNet CVs or LNCVs.

- After calling up the module (see chapter 4.1.1) the display of the Intellibox reads:

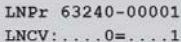

```
LNPx 63240-00001
LNCV: . . . . 0 = . . . . 1
```

- The cursor blinks under the 0.
- Enter the number of the LNCV you wish to program at the cursor position
- Press the [←]-key.
- The Intellibox reads the LNCV.
- The value is displayed at the right of the lower display row.
- Move the cursor to the right using the [→]-key and enter the value for the LNCV.
- The value is programmed by pressing the [←]-key.
- Move back to select another LNCV by pressing the [←]-key.

- Move back to select another Power 4 by pressing the [←]-key.
- Or press the [menu]-key to leave programming mode.

As is customary with the Intellibox marked numerical values in the display also can be incremented with the [+] -key and decremented with [-] -key.

4.1.3 The Universal Address 65535

With the universal address, as the name implies, generally all Power 4 can be called.

Since the universal address is not a clear address with which an individual Power 4 can be identified, it can only be used to call a Power 4, whose individual address is not known. Therefore only the particular device may be connected to the LocoNet. If it is then called the programmed address can be read from LNCV 0.

Procedure:

- Press [menu]-key
- Press [mode]-key
- Scroll to “LocoNet Prog.” with the [↓]-key.
- Continue with the [→]-key
- Enter the part number (63 240 for the Power 4)
- Press the [←]-key
- Enter the universal address 65535
- Press the [←]-key
- The individual module address in LNCV 0 is read and displayed.

4.1.4 List of LocoNet CVs

LNCV	Description	Value Range	Default Value
0	Module address	0-65534	1
1	Software version	-	varies
3	Settings	0-255	92
4	Starting phase waiting period in 0.5 s steps	0-255	6
5	Basic Settings	0-7	0
6	Operating temperature in °C (read only)	0-255	-
7	Power load in percent (read only)	0-100	-
8	Solenoid address for switching off single booster	1-2047	0
9	Data for Braking signal	0-255	0
10	DCC CutOut time in 7.5µs steps	0-255	63
11	Waiting period for automatic switch on after short-circuit, in 0.5 s steps (0 = do not switch on)	0-255	20

4.2 Power 4 Configuration

The Power 4 can be adapted to different operating modes according to the value in LNCV 3:

Bit	Value	Meaning	Default Value
0	0	DIP-Switch valid for basic booster settings	0
	1	LNCV 5 valid for basic booster settings	
1	0	Booster switch on/off by means of input signal on the selected booster input	0
	2	Booster switch on/off by LocoNet GO/STOP instruction	
2	0	Booster does not send an instruction via LocoNet to disconnect all boosters by the center	4
	4	Booster sends an instruction via LocoNet to disconnect all boosters by the center	

Bit	Value	Meaning	Default Value
3	0	Do not produce a switching off signal on the selected booster input, automatically switch on after a waiting period in according to LNCV 11	
	8	Produce a switching off signal on the selected booster input (Märklin or DCC Booster input)	8
4	0	Send no special LocoNet message for Short circuit or temperature disconnection	
	16	Send a special LocoNet message for Short circuit or temperature disconnection to the Intellibox II	16
5	0	Don not change track polarity	
	32	Swap track signal polarity for the use of crossed LocoNet cables or with swapped C and D of DCC Booster inputs	32
6	0	CutOut Hardware deactivated	
	64	CutOut Hardware activated (required for Selectrix operation)	64
		Factory setting of LNCV3	92

4.2.1 Basic setting via LocoNet

If the Power 4 is not to be configured by the DIP-Switch but by LocoNet CV, bit 0 in the LNCV 3 must be set. LNCV 5 can then be adjusted to the booster base setup. The following are valid:

Choice of booster input:

Switch 1	Switch 2	Bit0	Bit1	Value	Input
off	off	0	0	0	LocoNet
on	off	1	0	1	DCC Booster Input
off	on	0	1	2	Märklin Booster input

Switch	State	Bit	Value	Meaning
3	off	2	0	Normal Operation
	on		4	DCC brake generator
4	off	3	0	DCC RailCom CutOut off
	on		8	DCC RailCom CutOut on

4.2.2 Switching off behavior

The switching on and off the Power 4 can be configured in bits 1 to 3 of LNCV 3.

If Power 4 is connected with a LocoNet center bit 1 can specify whether the booster is to be switched on and off by the input signal or by the appropriate instructions which are sent over the LocoNet. Furthermore you can specify in bit 2 in the event of a short circuit at its track output or overheating, whether the Power 4 is to generate a LocoNet instruction to switch the entire layout off.

If the Power 4 is fed by the Märklin boosters input or the DCC booster input, bit 3 specifies whether the Power 4, in case of a track short circuit at its track output, or overheating a signal on these interfaces to switch the entire layout off, or whether in case of a track short circuit, the track output is switched on again after timeout specified in LNCV 11.

4.2.3 Switching Track Polarity

If the Power 4 is connected with a LocoNet center then crossed LocoNet cables should not be used. If the Power 4 is connected by a crossed LocoNet cable with a LocoNet center the rail signal polarity is swapped, and when crossing the isolation gap between the booster track section and the center track section a short circuit will occur. In this case the LNCV 3 bit 5 can be used to swap the input signal so that no short circuit develops when crossing the isolation gap.

The polarity swap can likewise be used if lines C and D were exchanged on the DCC booster input when connecting the Power 4.

4.3 Power 4 single switch-off and monitoring

If the Power 4 is connected to a LocoNet center, it can be switched off, independently from all other boosters and the center. For this Power 4 is assigned a solenoid address via which it can be switched off and monitored. This solenoid address is registered in LNCV 8. It should be a solenoid address which is not used by another solenoid (switch or signal). When the solenoid is in the “green” state the booster is switched on. The “red” state of this solenoid address switches the booster off.

If a short circuit arises on the Power 4 track output or if the booster is overheated, the Power 4 changes the state of this solenoid address to “red”. Hence the Power 4 can be controlled and monitored by this solenoid address.

If this feature of the single disconnection is not to be used LNCV 8 must contain the value 0.

Note: *If the Power 4 is operated only via the LocoNet and if the bits 1 and 2 are set to 0 and bit 3 to 1 a solenoid address must be entered in LNCV 8, so booster can be restarted in the case of short circuit.*

4.4 Load and operating temperature of the Power 4

The operating state of the Power 4 can be queried during operations by LocoNet CV. LNCV 6 contains the operating temperature of the Power 4 in °C. LNCV 7 contains the present load status in per cent. Both LNCV's can be selected during operations without switching the booster off.

5. Reversing Loop Automation

5.1 Description

In both analogue and digital layouts the construction of a reversing loop in 2-rail layouts inevitably leads to a short circuit and the booster switched off. A short circuit is prevented by supplying the power to isolated section via a special module. Then a vehicle can travel through the reversing loop trouble free.

The Power 4 has such a reversing loop module for 2-rail operation (DCC, Märklin, trace I, Selectrix).

The booster controls the reversing loops via external relays, which are attached to terminals 1 and 3 of screw terminal strip 1.

The reversing loop mechanism works in every operating mode of the booster.

5.2 Connection

Up to 7 reversing loops can be attached to the Power 4. Each reversing loop is connected to the booster by a relay component 61080. Each connected relay can drive only one reversing loop.

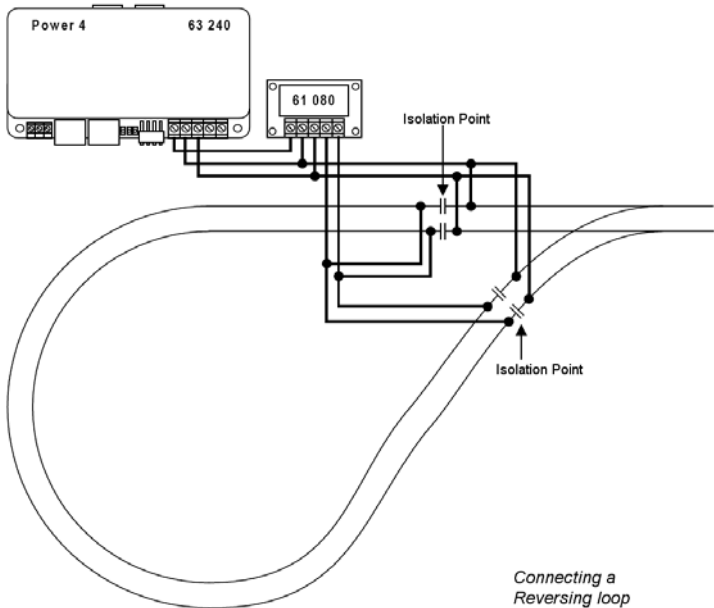

If different sections in a reversing loop are to be monitored with a feedback module 63340 then a relay component 61080 must be used for each track section that is to be monitored. The following diagram shows the principle for two reversing loop sections.

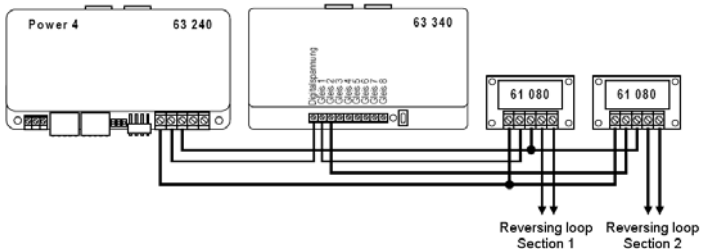

VERY IMPORTANT: The reversing loop track must totally be isolated on both sides!

IMPORTANT: The tracks which contact the insulated reversing loop must be fed by the normal track output of the booster to which the reversing loop is also connected.

Since the reversing loop mechanism is controlled by the locomotive crossing the interface the tracks should be connected with the reversing loop output, if possible, in close proximity to the isolation point, as with the booster's normal track output.

6. Brake Generator

6.1 Description

A brake generator ensures that locomotives with DCC digital decoders with decoder brake delay stop correctly before a signal.

For this procedure a special brake signal is needed. In addition the wiring must guarantee that a short circuit will not result when the locomotive crosses the isolation between the brake section and the normal track section.

The brake generator monitors each individual brake section. As soon as the train is completely in the brake section the supply is switched from the normal booster to the brake generator.

6.2 Choice of socket for the control signal

The Power 4 can receive its control signals from Motorola, DCC or LocoNet centers. The devices DIP switches must be adjusted accordingly.

Switch 1 Off, switch 2 Off – if the device is connected to an Intellibox or another LocoNet center by the LocoNet socket.

Switch 1 Off, switch 2 On – if the device is connected to an Intellibox or a Märklin Central Processing Unit by Socket 2.

Switch 1 On, switch 2 Off – if the device is connected to a DCC Center (Lenz LZ100, Arnold 86200) by the Socket 4.

6.3 Choice of operating mode

To operate the booster as a brake generator the DIP switches must be set up accordingly.

Switch 3 On – to enable brake generator operation.

6.4 Connection

A driving and stopping section is installed before each signal. These are switched to brake generator operation as soon as the change over switch is triggered by a train being in the stopping section.

In order to avoid short circuits the driving section prior to the stopping section must be at least as long as the longest operating train.

The length of the stopping section must be selected in such a way that all locomotives with the selected brake delay come to a halt within the section. The occupation detector with relay (GBM 43400) can be used as change over switches to control the train.

The power supply can be from the Intellibox booster, a further Power 4 (Part No. 63240) or a Märklin booster (6015 or 6017).

The switch S1 in the diagram must be an *opener*. It can be a switch in the signal or a switch operated by an additional relay.

During Signal “green” state the switch must be open so that the track occupation alarm unit remains in its rest state.

In this situation the entire block section is supplied its digital power by the center or a booster.

During Signal “red” state switch S1 must be closed, thereby the track occupation alarm unit (e.g. GBM 43400) can monitor the stopping section.

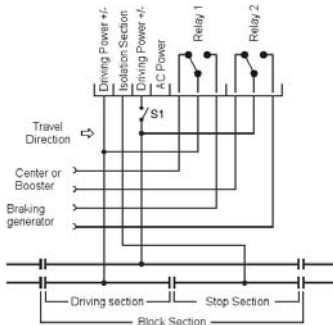

If a vehicle is reported in the stopping section the complete block section's supply is switched over to the brake generator.

6.5 Brake Generator without connecting to the center

If the booster is to be used as brake generator without short circuit feedback and without switch from the center, the brake generator operating mode and the Märklin signal input are to be set up. The cable to the center can then be disconnected.

In the event of a short circuit the booster switches the brake section off for approx. 10 seconds. Afterwards the track power is automatically restored. If the short circuit is still present the booster again switches off for approx. 10 seconds. The brake section cannot be switched off from the center.

7. RailCom

The booster is prepared for RailCom. It makes the “RailCom CutOut” available if it receives a DCC input signal and the DIP switch 4 is switched on.

8. Error Indication

The Power 4 reports errors by different flashing signals of the red and green LEDs.

green LED on – red LED off

“go”-key pressed

Track Power is switched on (normal operating state).

red LED on – green LED off

“stop”-key pressed

Track Power is switched off by the center.

green LED off – red LED blinking

Short circuit on the Track.

LEDs blink alternately 1 x rot - 1 x green

Overheating, Track power is switched off.

LEDs blink alternately 1 x rot - 2 x green

No Input signal.

Authors: Dr.-Ing. T. Vaupel, D. Richter, M. Berger
Translation: Wolfram Steinke

© Copyright Uhlenbrock Elektronik GmbH, Bottrop
1st Edition August 2009
Base Software Version 1.0
All rights reserved
Reproduction in full or in part only with permission



02045 If you have any questions call us. Hotline times are:
8583-27 Mon - Tue - Thu - Fri, 14:00-16:00 and Wednesdays 16:00-18:00

Our products are covered by a two year warranty. If it is defective send decoder
along with the receipt of purchase to the following address:

Uhlenbrock Elektronik GmbH * Mercatorstr. 6 * 46244 Bottrop
Tel: 02045-8583-0 * Fax: 02045-8684-0 * www.uhlenbrock.de